

Introduction

Integration Guide

Revision V1.0

The ES9038PRO SABRE DAC - Bringing Music to Life

The ES9038PRO SABRE DAC is the flagship of the ESS PRO series. It sets a new benchmark for audio excellence with the industry's highest dynamic range (DNR), up to 140dB, in a 32-bit, 8-channel DAC. The ES9038PRO was designed for premium home theater equipment including Blu-ray players, preamplifiers, all-in-one A/V receivers, and more. For serious audiophiles it provides the most immersive listening experience — bringing music to life.

The ES9038PRO SABRE DAC also features ESS' patented 32-bit HyperStreamDAC technology with 122dB total harmonic distortion plus noise (THD+N). The HyperStream architecture is responsible for both the outstanding sound quality of the ES9038 and the extremely low THD+N. A typical competitive, 32-Bit 8-Channel DAC using a delta-sigma architecture features 107dB THD+N (0.0004%), which when subjected to listening tests does not equal the clarity and sound stage of the ES9038PRO.

Es9038 PRO DAC - Design by Andrea Ciuffoli-Quang Hao

- Based on the ESS Sabre32 Reference (ES9038PRO) DAC chip
- Support 44,88,96,192,352,384KHz PCM and DSD to play SACD ISO.
- Full ground isolation from USB module
- On board reference 100MHz Crystek oscillator with a jitter of 0.5psecUltra fast oscillator buffer

Output: Stereo balanced output impedance: $202 / 4 = 50 \text{ ohm}$

- DC-output: +1.65VDC.
- Output impedance: 100 Ohm.
- Output: 2-Channel (stereo) outputs can be used in current-output or voltage-output mode (depends on output stage used)

Input: 4 inputs:

- 1. USB -match with Amanero USB (not included). Have pin I2C for other USB
- 2. Spdif
- 3. AES/EBU.
- 4. Optical

Digital supply:

- 1.2V core: LT3042
- 3.3V oscillator: LT3042
- 3.3V digital: LT3042
- 3.3V Top-bottom chip
- 3.3V USB: LT3042 (If you not like us 3.3v from Computer for USB)

Analog supply:

- 1.2V analog (left and right separated): LT3042
- 3.3V analog (left and right separated): LT3042
- 5V for LCD: LT1117
- 5V Analog supply: LT1117
- 5V Digital supply Digital supply: LT1117

On-board DAC ESD9038PRO includes:

1. ES9038PRO chip.
2. Clock 100MHz CCHD-575, Ultra-Low Phase Noise Crystal Oscillator.
3. All Input connectors, Amanero USB (not included)
4. All low noise Lt3042
5. Lm1117

Use: it is simple and need:

1. Transformer 15VA to 25VA: 2 x 6 - 8VAC: Talema 70050 or Talema 70060 Or equivalent
2. Use LCD Control board off Andrea-quanghao for ES9038PRO, ES9028PRO

ES9038PRO Board

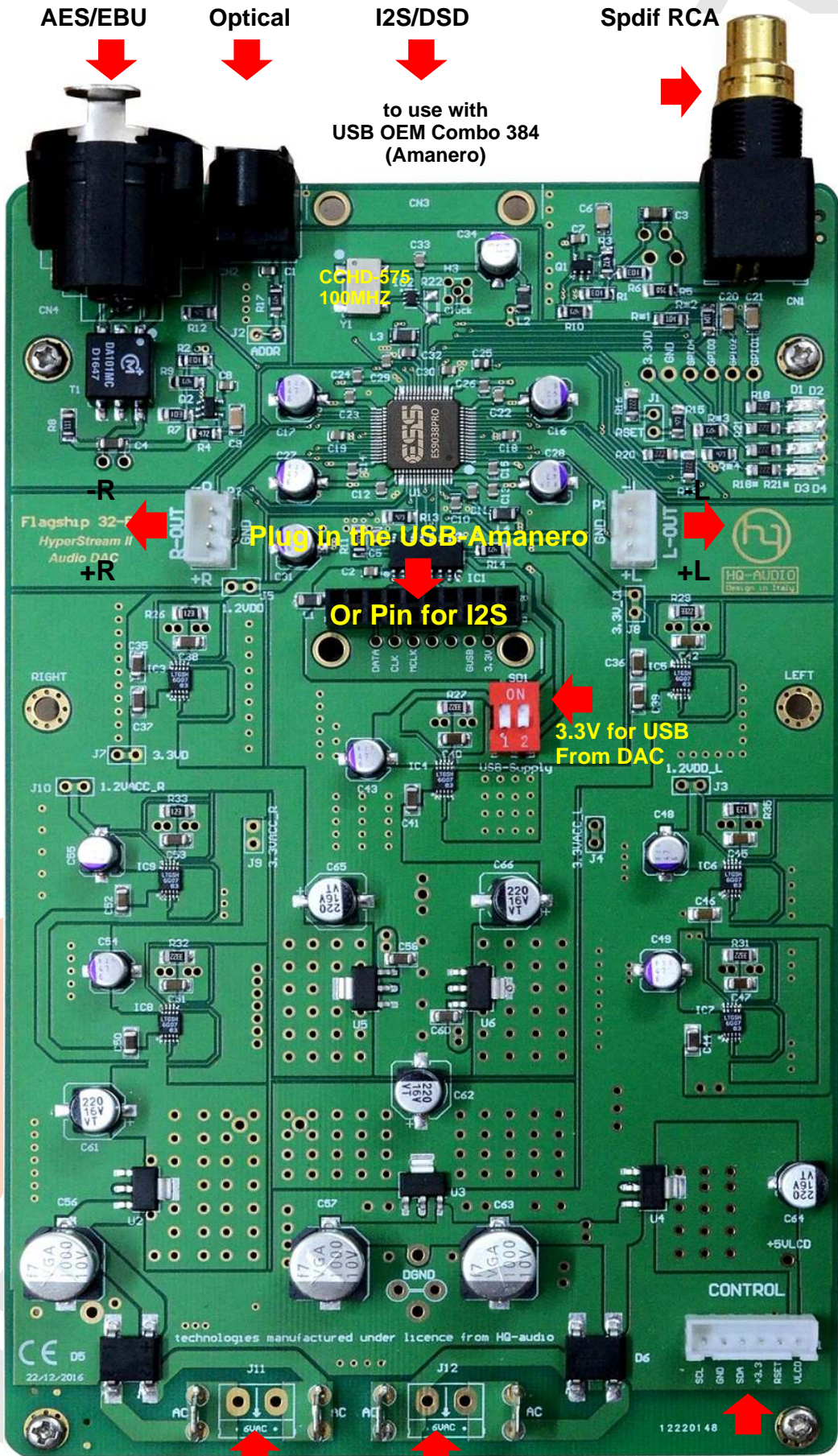

AES/EBU

Optical

I2S/DSD

Spdif RCA

to use with
USB OEM Combo 384
(Amanero)

CCHD 575
100MHZ

Plug in the USB Amanero

Or Pin for I2S

3.3V for USB
From DAC

Channel R
Output
DC= +1.65V

Channel L
Output
DC= +1.65V

AC input
6-7.5V/1A x 2

Connect to LCD board
wire 6 pin

Design

Structural design
the flagship of the ESS PRO series

ES9038PRO
ES9028PRO
ES9018S

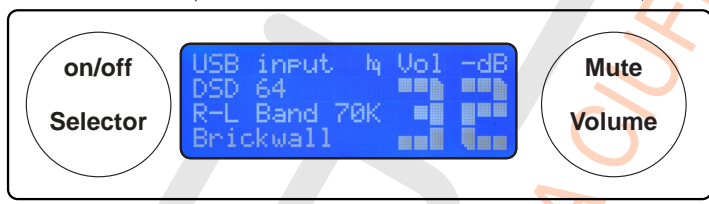
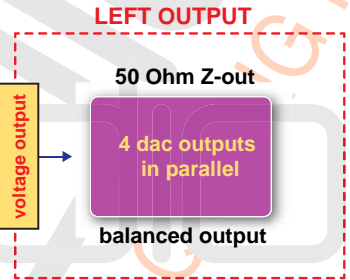
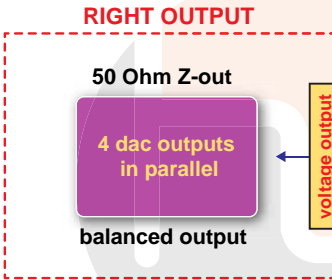
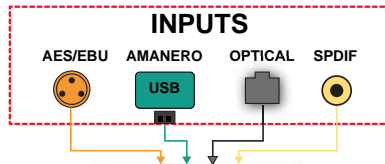

remote control

ES9038PRO POWER SUPPLY

Supply Analog right

Supply Digital

Supply Analog left

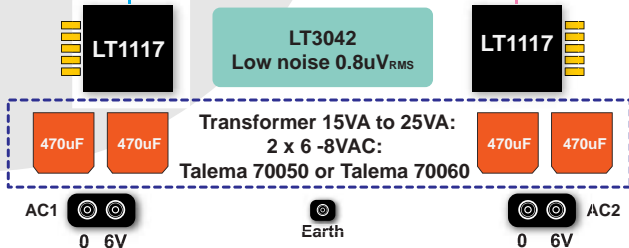
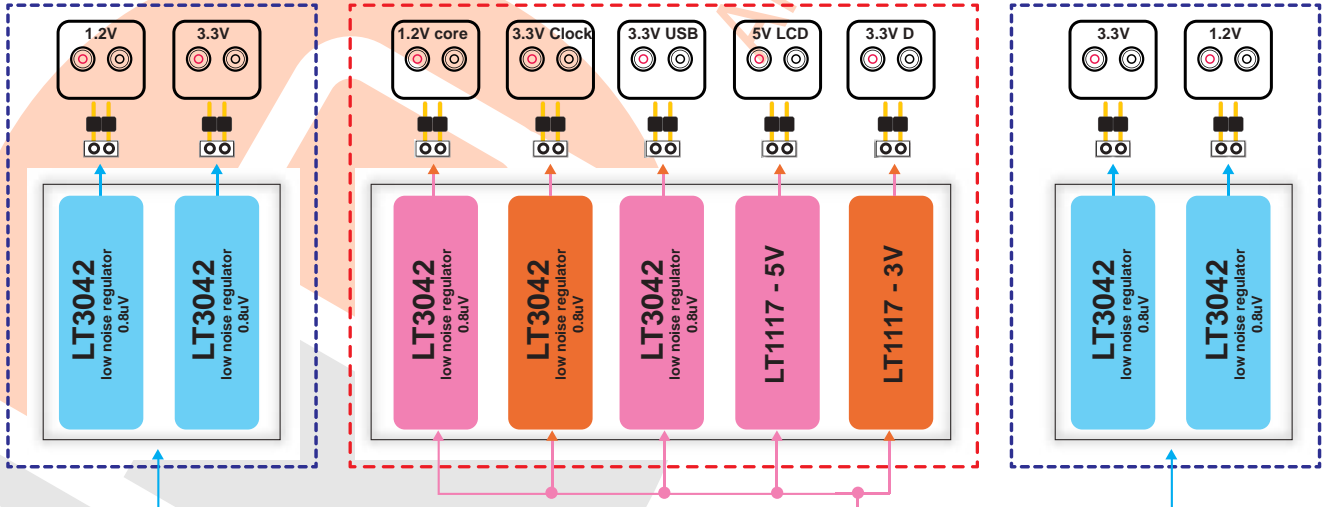

AC1 0 6V Earth AC2 0 6V

Use 3.3v on DAC for USB Amanero:

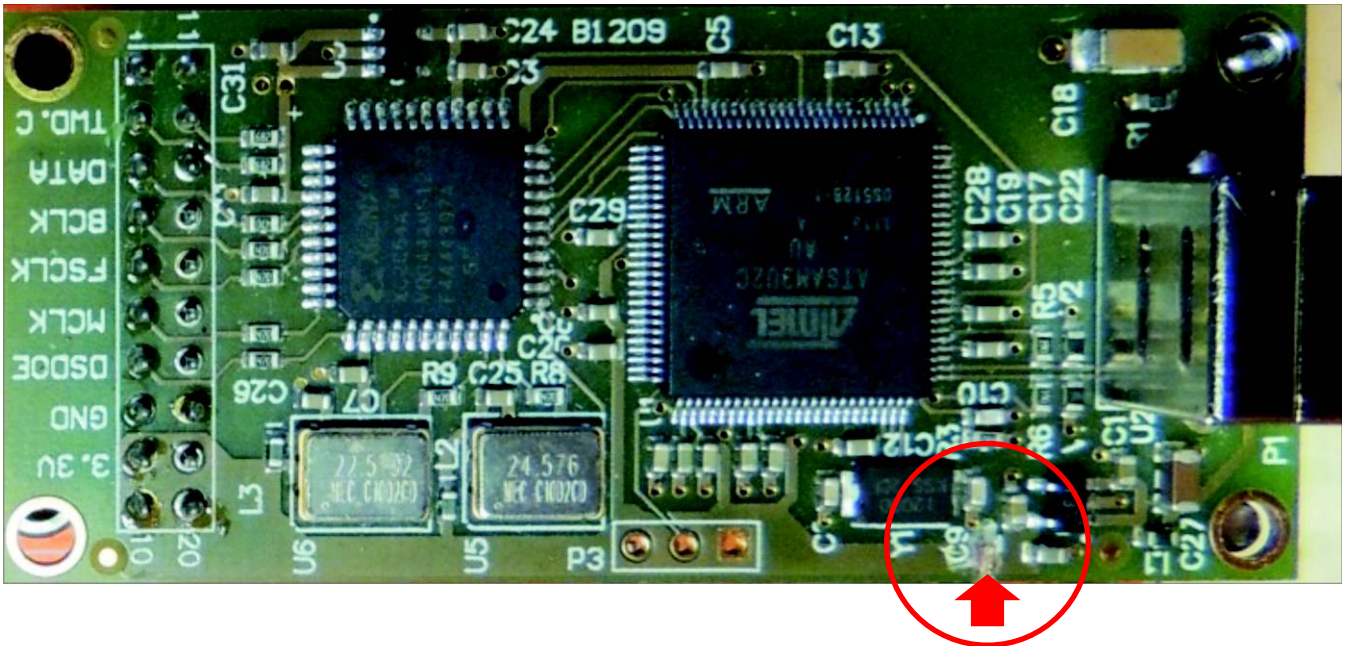

Cut off the circuit at position C9
(remove 5 VDC from the computer)

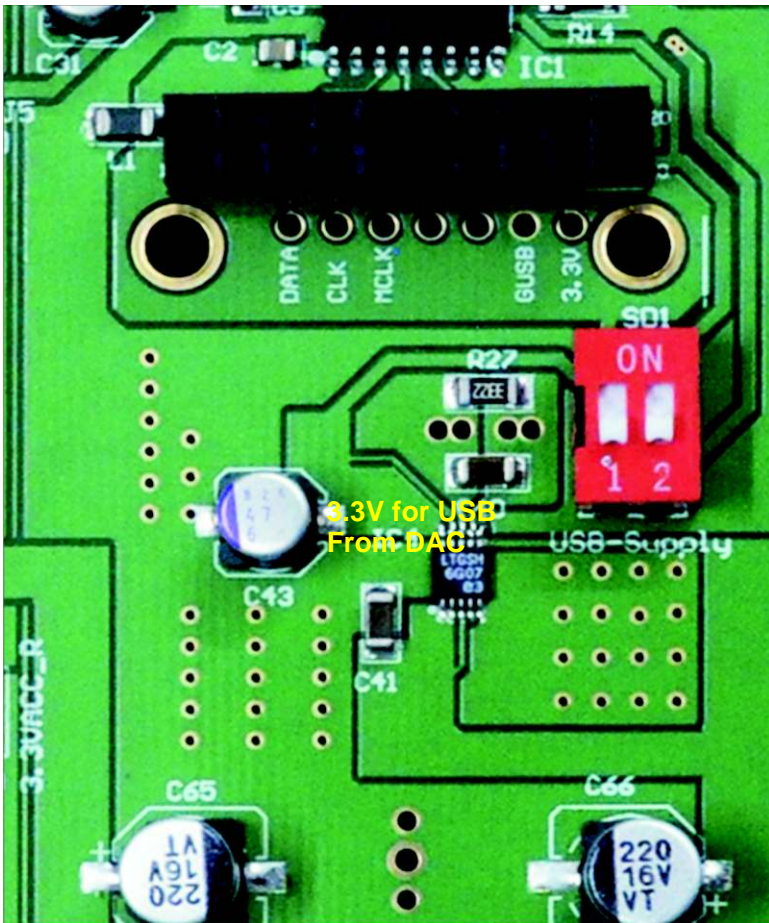

Turn on switch Sd1
to position On

USB use 3.3V from DAC

Board size

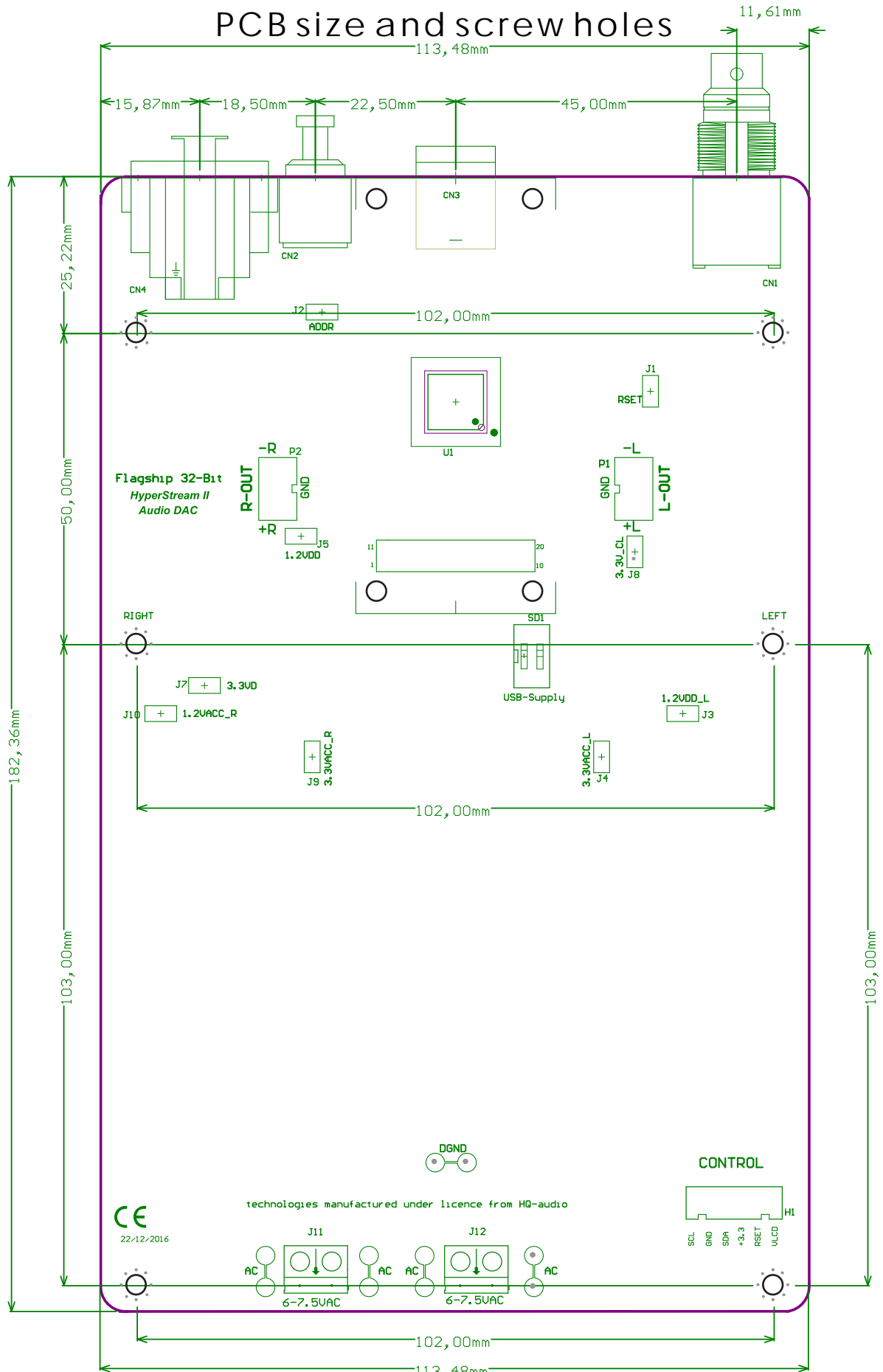

Board size

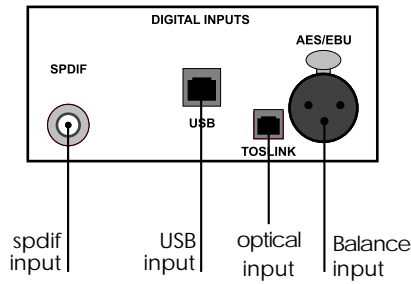

Hole in the back

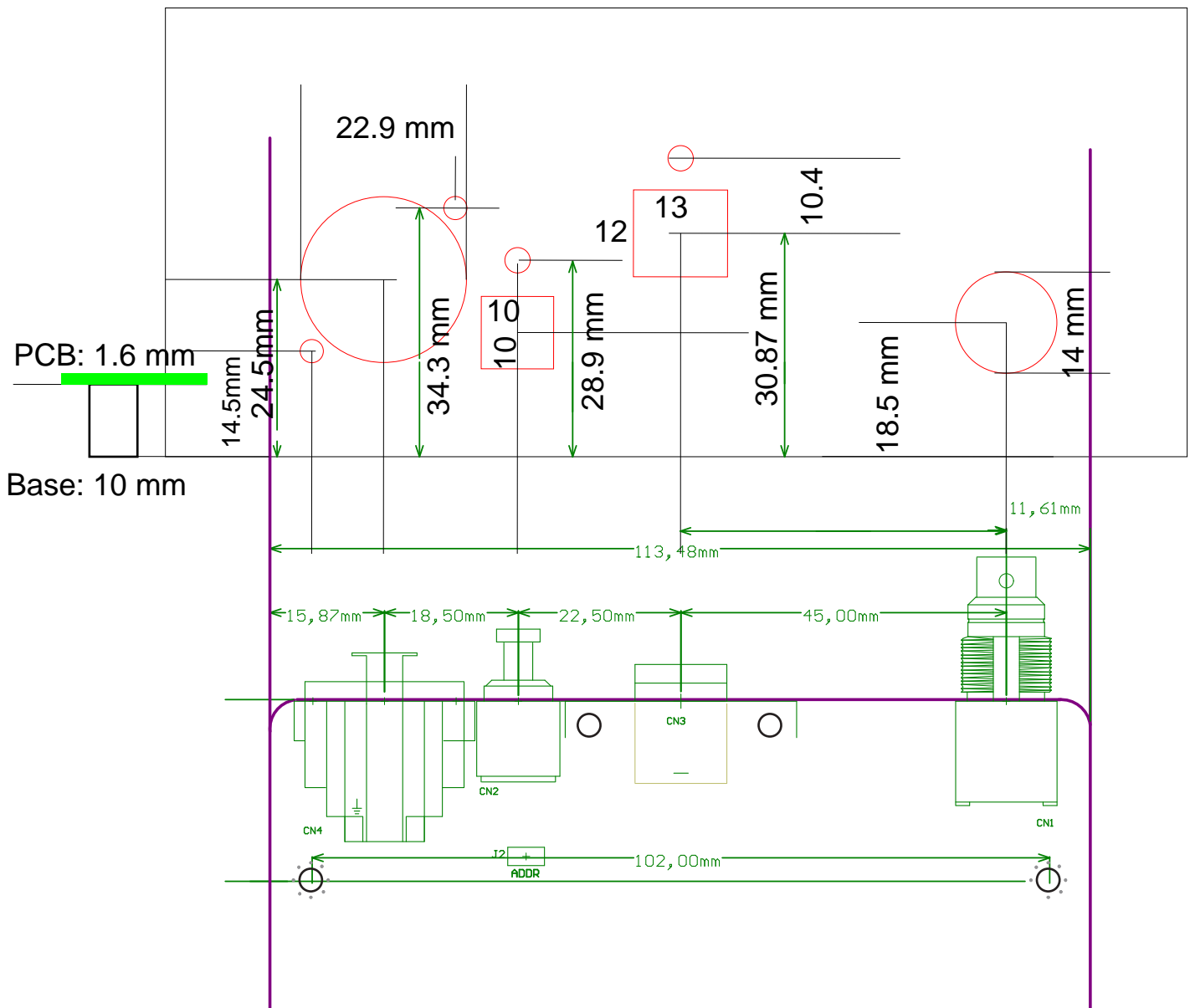

Siz PCD DAC

Controls and features

1. Standby mode.
2. High volume display.
3. 20 x 4 LCD display.
4. Select the 4-way input and display the frequency on the LCD screen
5. Fuse protection - 220 VAC power supply / 5W
6. Turn on, off with remote control or buttons.
7. Simple and appropriate use for DAC chips: ES9038PRO, ES9028PRO.
8. Set up customizable protocols such as: volume, input as you like.
9. Select modes such as filter, frequency, left channel right.
10. Special and unique - Store settings according to your preferences:
 - A, Keep the big picture to the desired: lowest -100dB, largest 0dB.
 - B, Select and store left or right channel output - No need to reverse the output.
 - C, Selectable filter modes: (Pass band): 47kHz, 50kHz, 60kHz, 70kHz.
 - D, Option: PCM Filter Characteristics
 - E, Selectable filter modes: (Pass band): 47kHz, 50kHz, 60kHz, 70kHz.
 - F, Option: PCM Filter Characteristics: Fast, Slow Roll-Off, Apodizing, Hybrid, Brickwall.

Board Control

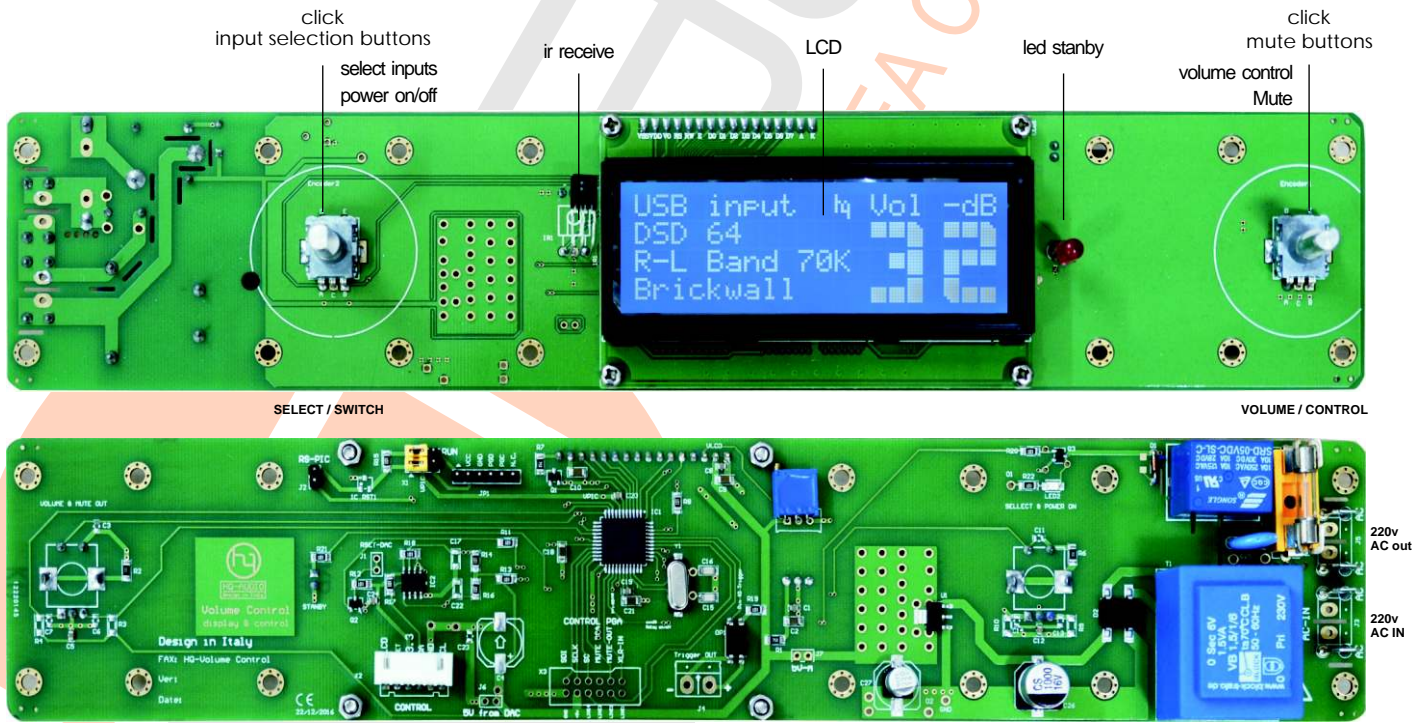

Connect to DAC board



DAC connection and control



Remote

Information on LCD

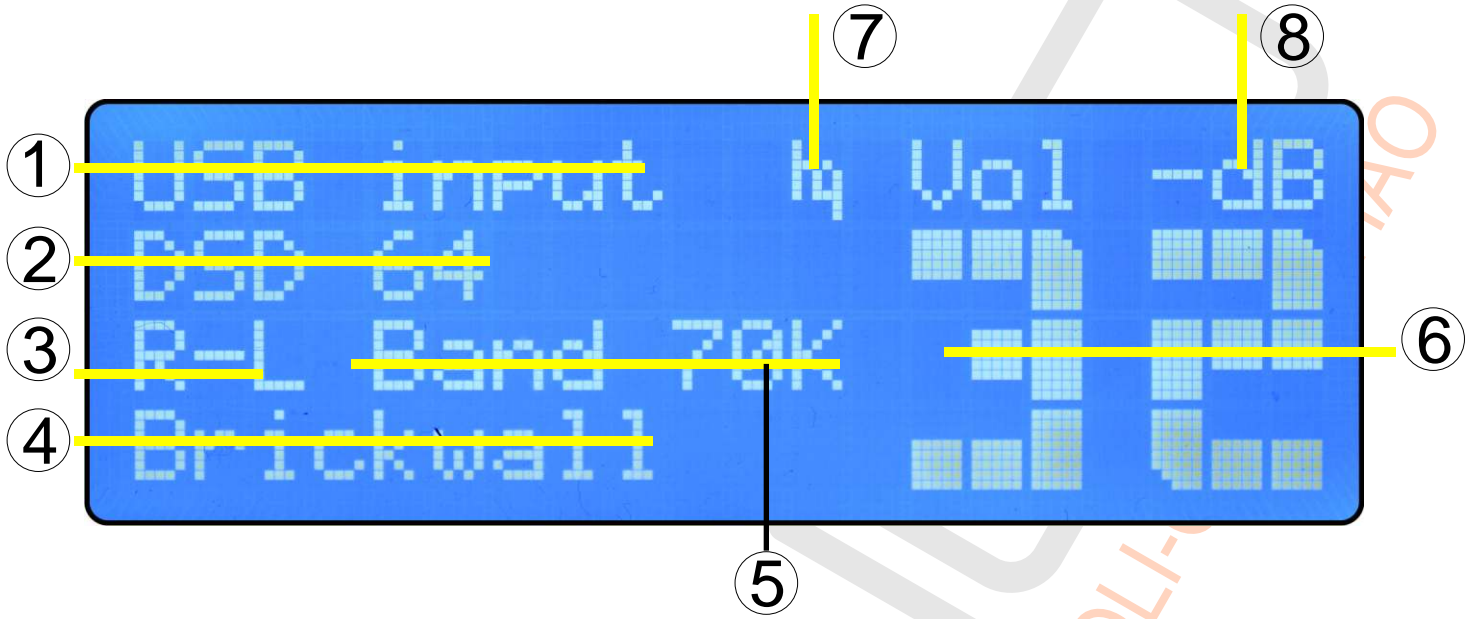

1. Digital input: USB, AES/EBU, Spdif-RCA, Optical
2. Input frequency
3. Select Left Channel Right Channel
4. Filter
5. Band Filter: 47kHz, 50kHz, 60kHz, 70kHz
6. Volume: maximum is 0 dB, minimum is -99dB
7. Logo HQ
8. Volume dB

Remote control

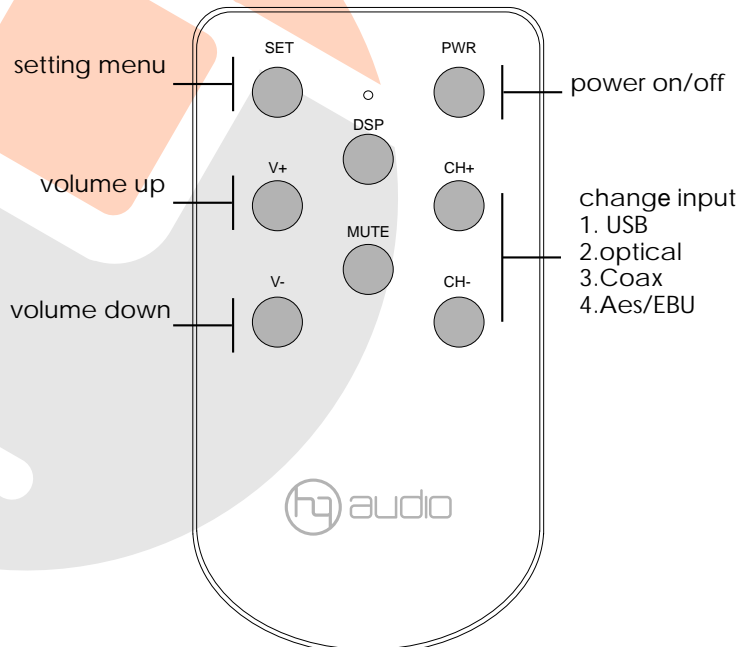

PCM Filter Frequency Response

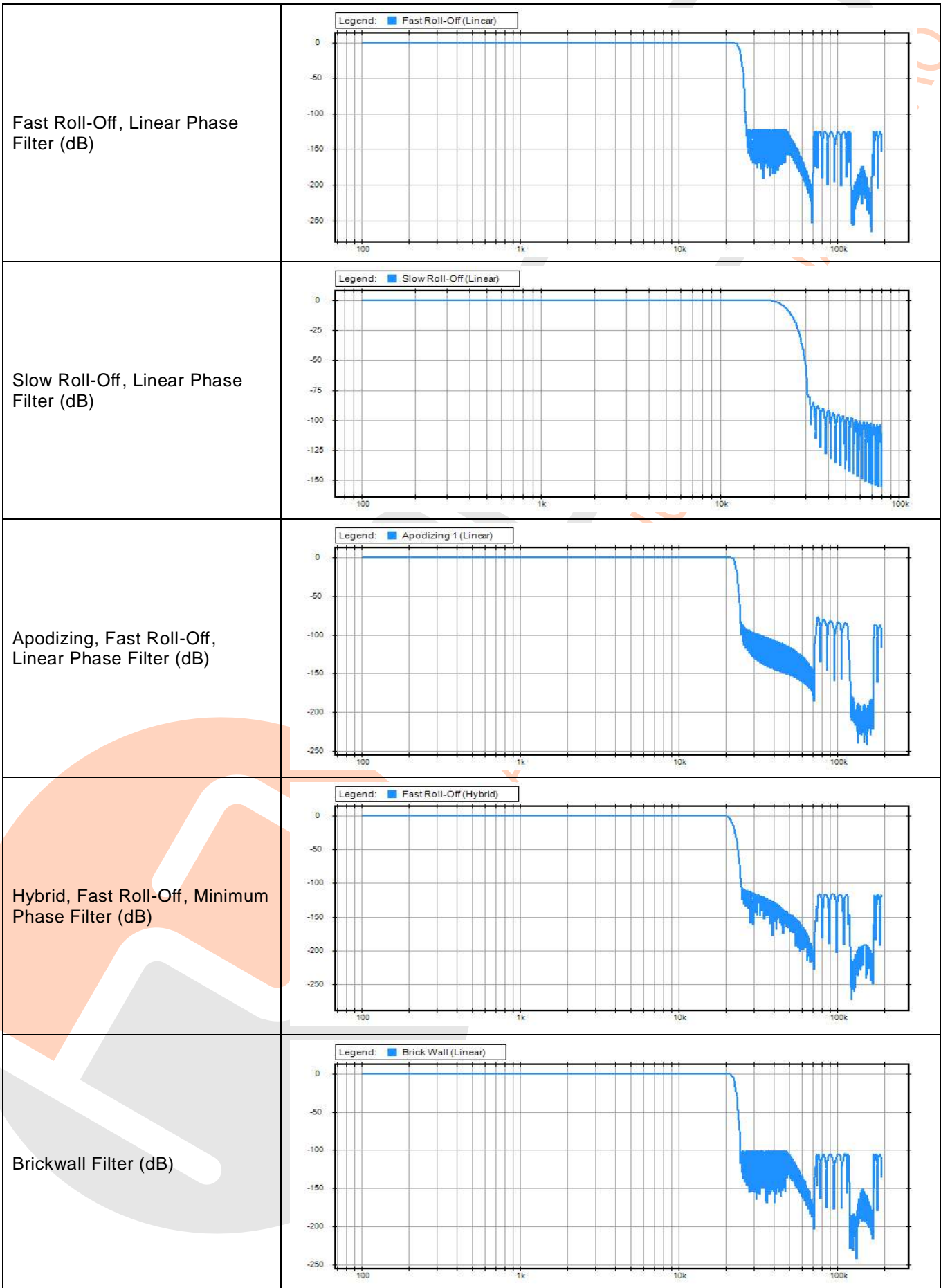

Control guide

Use the remote control to set and remember settings such as:

- Volume,
- input,
- left-channel right channel,
- filter modes,
- filter frequencies.

Using:

1. On the remote control, press: SET, LCD display text: settings.

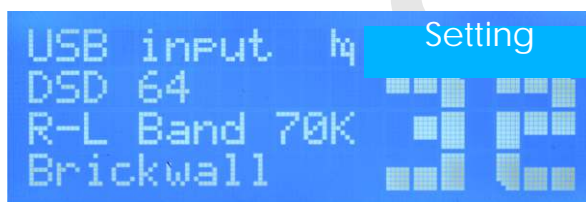

2. Press the install options button:

- a, V +, V-: filter selection.
- b, DSP: island left channel and right channel output (L-R)
- c, CH +, Ch-: select the filter frequency.

When the installation is complete, press the button: Mute to save all the settings, and press the SET button to exit the program.

Then, restart the DAC, and play the music!

Thank you!

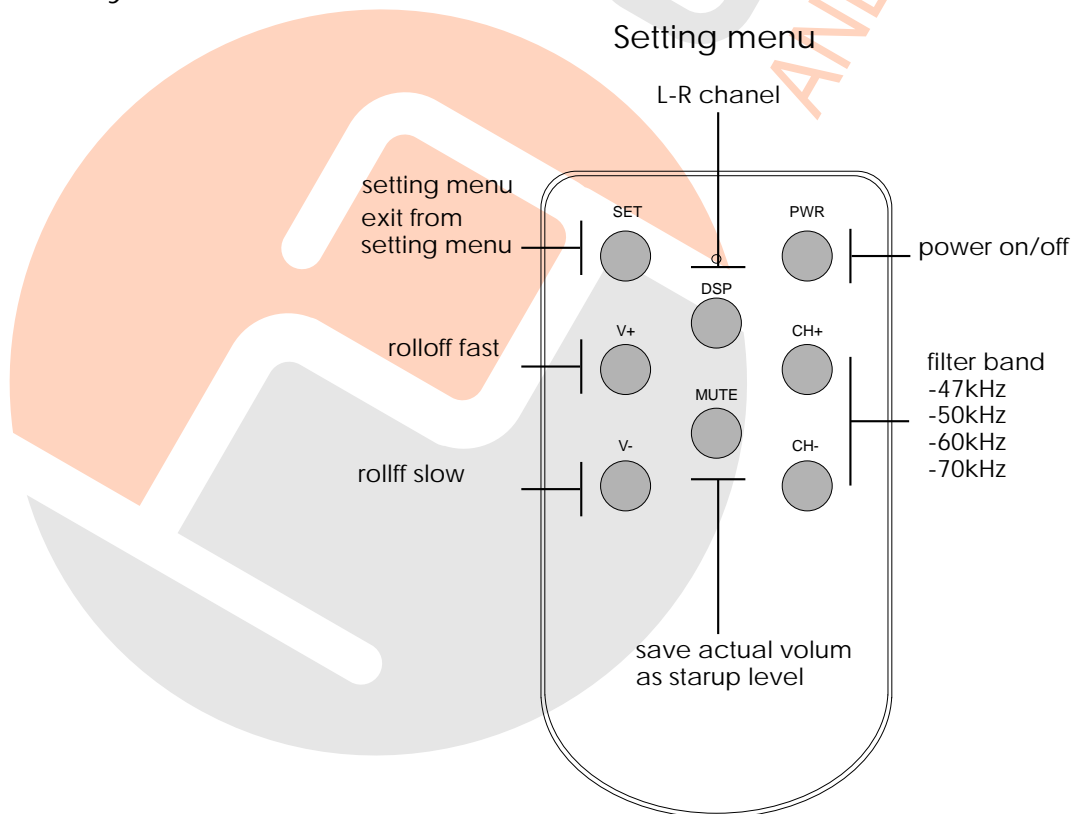

Control drawing

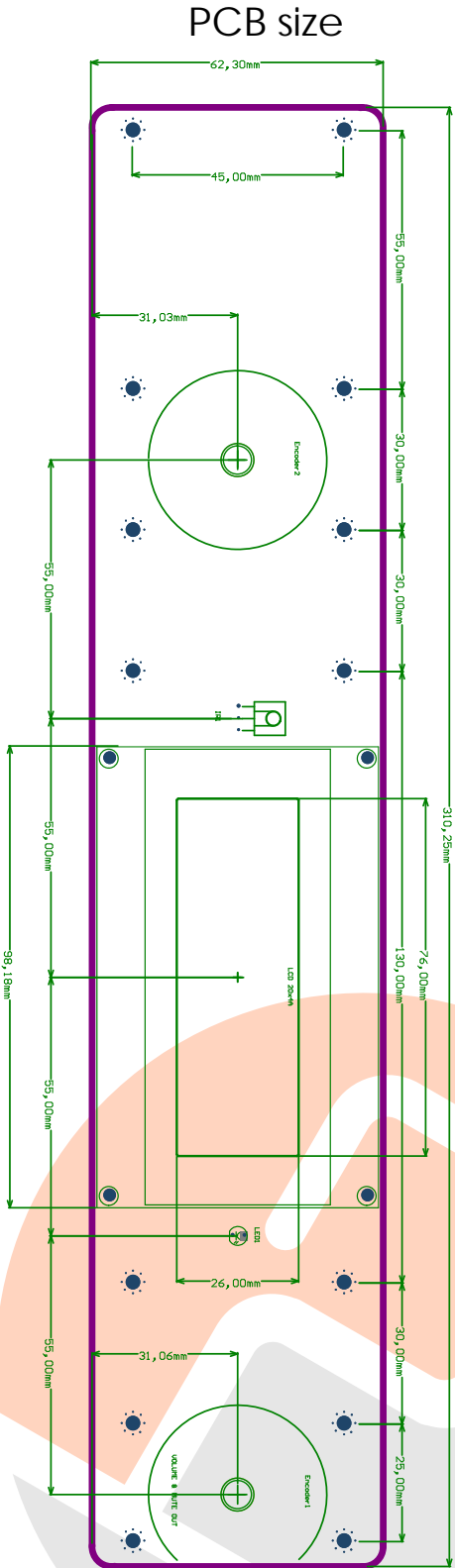

view from the back

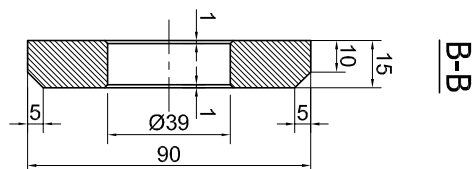
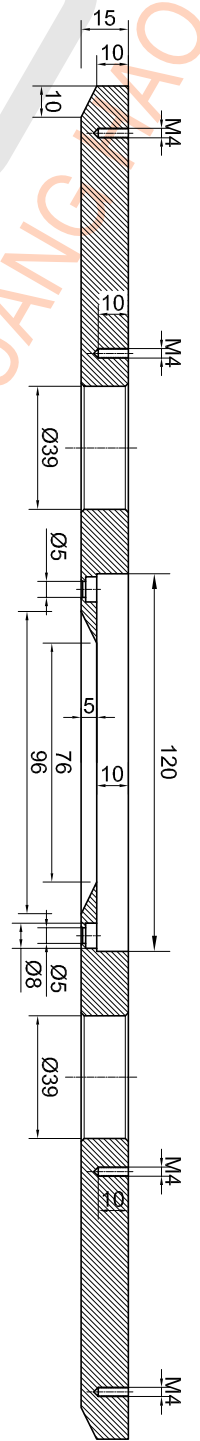
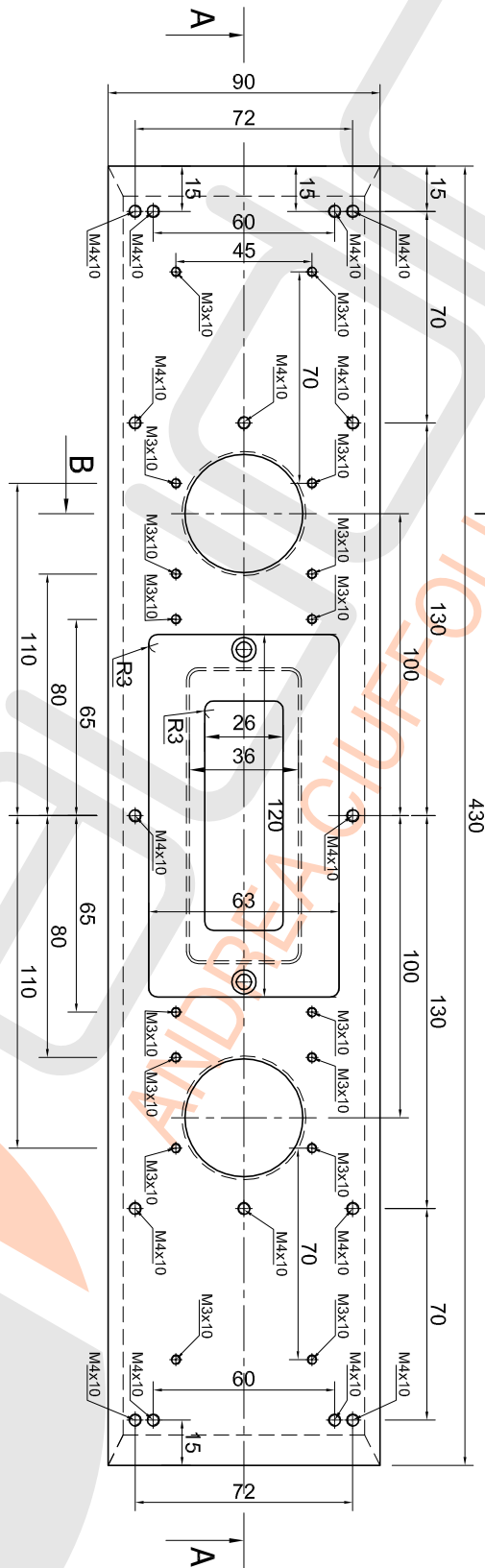

Music player setup.

The Music player

To use Hq- Reference DAC and DSD-DAC with all the PCM sampling frequency and DSD sample rates, it is necessary configure the Music player (Foobar2000, Jriver or similar) to use: Windows Audio Session API (WASAPI), Kernel streaming (KS) or Audio Streaming Input Output (ASIO).

Using the default Windows driver called Direct Sound (DS) the DAC unit will work only at a specific frequency set in the Windows Audio control panel.

To work with the Kernel streaming (KS) and the Audio Streaming Input Output (ASIO) it is necessary set as predefined a different sound device on Windows Audio control panel to keep the Amanero free for the application control.

The Kernel streaming (KS) is the lower level mode to operate on Audio device so there are lower stratification in the software stack. The Windows Audio Session API (WASAPI) give less problems and it work very good with PCM and DSD tracks. Set the Windows with no sound to avoid that the system messages interference during the reproduction.

To use Foobar2000

To use Foobar2000 is much more complex

You can follows the guide on: <http://hifiduino.wordpress.com> or this following images.

download the last player SACD support (foo_input_sacd-0.6.1.zip to get foo_input_sacd.dll and ASIOProxyInstall-0.6.0.zip) ASIO4ALL (ASIO4ALL 2.11 Beta1 to get foo_dsd_asio.dll)

Kernel Streaming support necessary to play 384KHz tracks (foo_out_ks.dll)

copy foo_input_sacd.dll, foo_dsd_asio.dll and foo_out_ks.dll in the directory C:\Program\foobar2000\components

If you select as output device the ASIO4ALL when you start to play any tracks an little icon will be insert in the Appl. Bar.

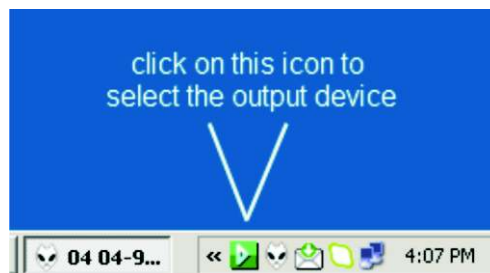
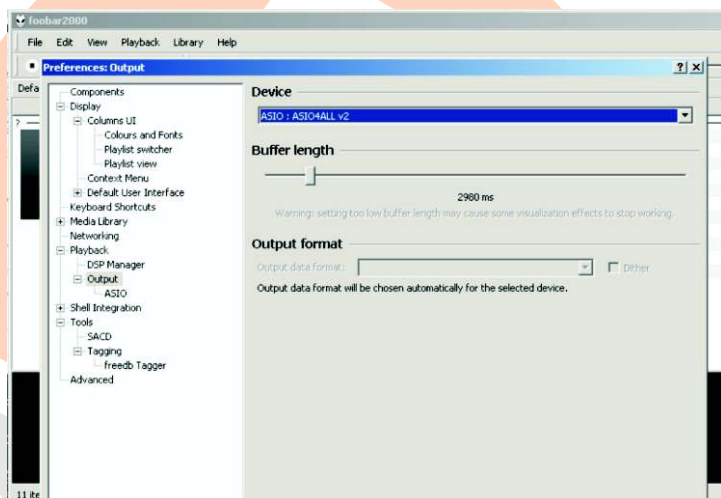

Music player setup.

JRiver DSD setting screenshots

The JRiver is more simple and with this configuration you can play 44,88,96,192,384KHz, DSD files and SACD ISO.

download the last player: <http://www.jriver.com>.

it's best to buy a license for Jriver

Direct Stream Digital, also known as DSD format - this format is not new as many people think, it is as old as digital but it wasn't used for consumer audio or home audio - before. It became very popular after 2010 and continues to make its way into our homes.

It encodes the music in the data stream differently, looks differently and sounds differently. It is the format in which the SACD discs were recorded and a format in which the analog master tapes were backed up by record companies. It is currently the format in which the master recordings are made in record industry.

1. Open Jriver and Tool/Options
2. Tool/Options/Audio

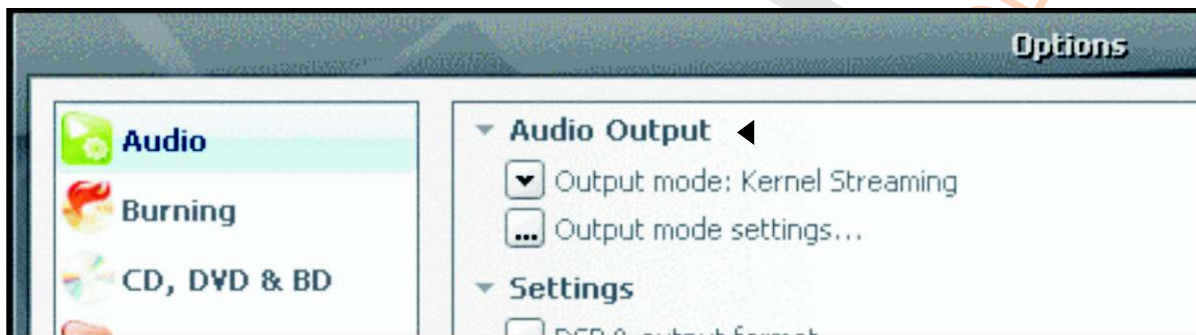

2. Audio Output /Output mode/ kernel Streaming



4. DSD over PCM(DoP)
DoP Format: DoP 1.0 (0xFA / 0x05)



3. Audio Output /Output mode/ Bitstreaming: Yes over PCM(DoP)



5. Ok and save
Now playing

Music player setup.

Audirvana on MAC OS configuration:

The **Audirvana** is more simple and with this configuration you can play DSD files and SACD ISO.
download the last player: <https://audirvana.com/>

it's best to buy a license for **Audirvana**



General Optimization

- Deactivate completely iTunes own playback
Note: this option should be enabled for playing proxy files

Sound Quality optimizations at the expense of convenience functions

- Deactivate volume control by iTunes
- Deactivate play position control by iTunes

Native DSD Capability: DSD over PCM standard 1.0

Max sample rate limit: No Limit Spl rate switch: Limit max bitdepth to 24bit instead of 32bit

- Optimize System for Audio Playback
 - Audirvana Plus priority: Very High
 - Disable Spotlight
 - Disable Time Machine
 - Disable detection of iDevices on USB

Converter: iZotope 64-bit SRC

Quality: Fastest ————— Best

Advanced parameters

Steepness: 97 dB

Filter max length: 500,000 Samples

AudioUnits

- Use AudioUnits effects
 - No Effect
 - No Effect
 - No Effect
 - No Effect